

DREAMSEAT

Need a deeper massage?
Remove Softening Pad

- 1 Unzip
- 2 Fold Down
- 3 Remove Pad

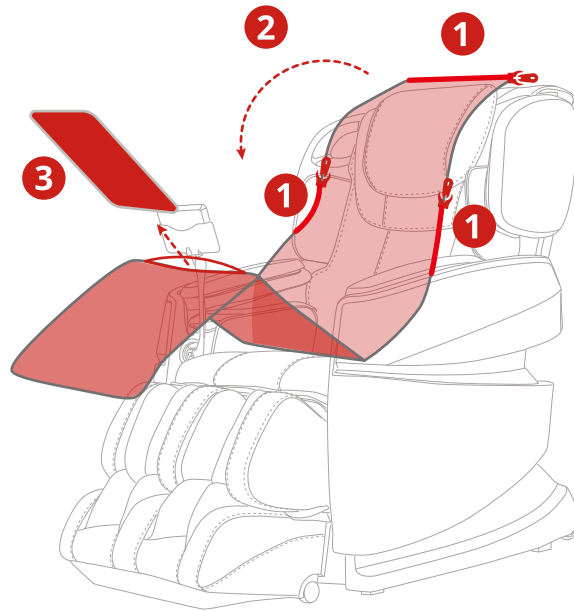
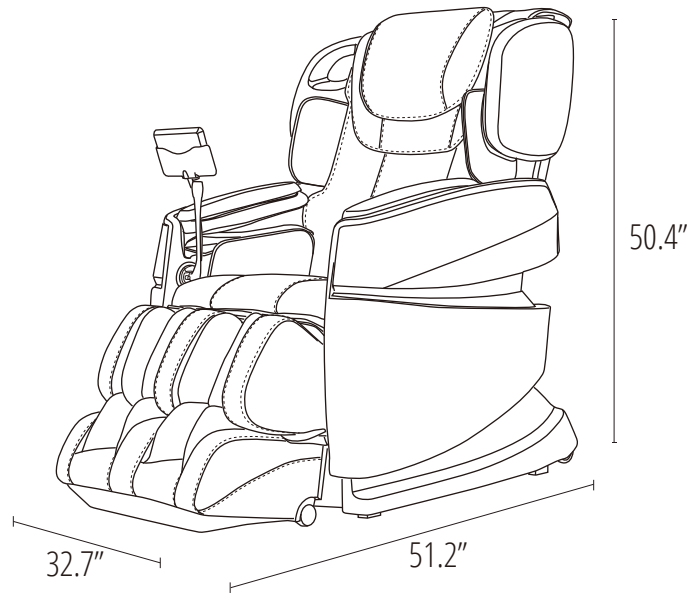

TABLE OF CONTENTS

	Dimensions	3
INTRO	Contents	4
	Move & Clearance	5
CHAIR	Components	6
	Massage Points	7
	Specifications	8
	Interface	9-12
	Pre-Programed Massage	13-18
	Demo	19-20
MASSAGE	Custom Massage	21-25
	Spot Massage	26-28
	Settings	29-34
	Auto Program Descriptions	35-38
	Safety	39-41
	Grounding Instructions	42
CARE	Troubleshooting	42
	Care and Storage	43
	Warranty	43-44

DIMENSIONS

First, let's get your chair inside.



Box 1

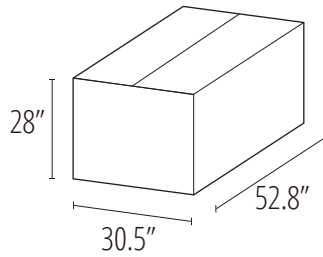

Seat Base

Box 2

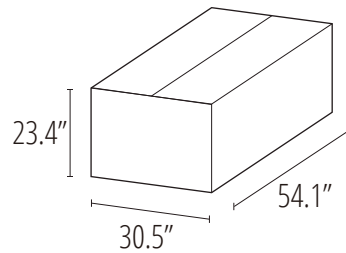

Backrest

Box 3

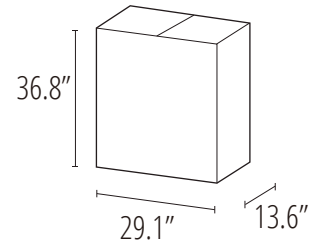

Side Panels

CONTENTS

Everything you need for a relaxing experience.

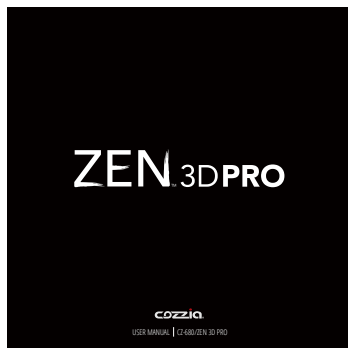

User Manual



Installation Manual



Warranty Postcard

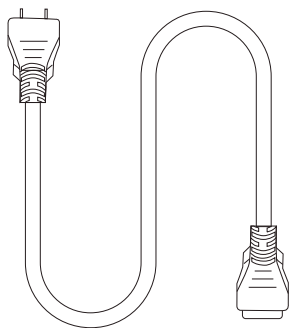

Power Cord

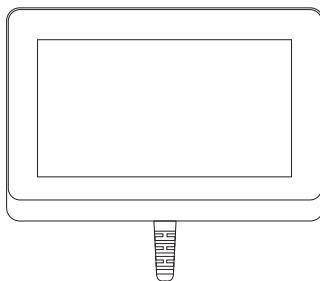

Wired Touch-Pad

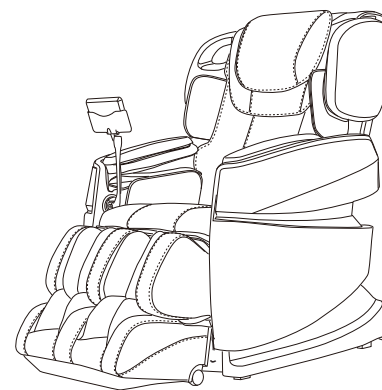

CZ-680 Massage Chair

Move & Clearance

A few simple steps to find the best place for your new chair.

HOW TO MOVE

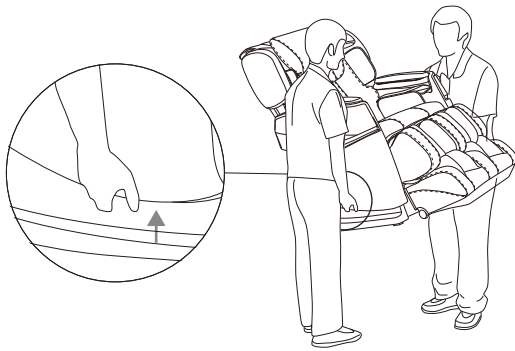

Lift and hold the bottom of the chair

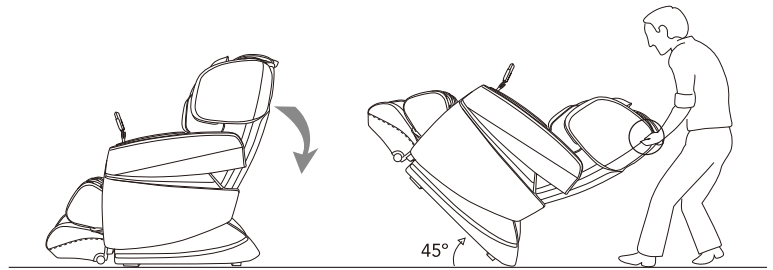

Lower down the backrest 45 degrees onto wheels

CLEARANCE

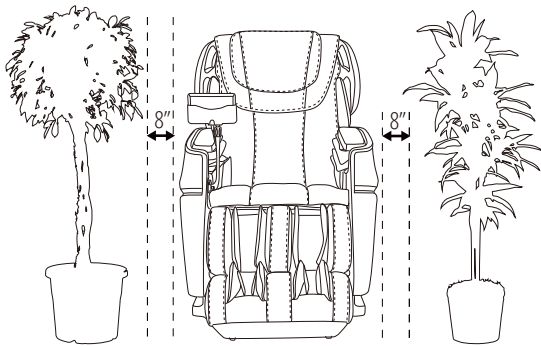

Reserve space on the left and right

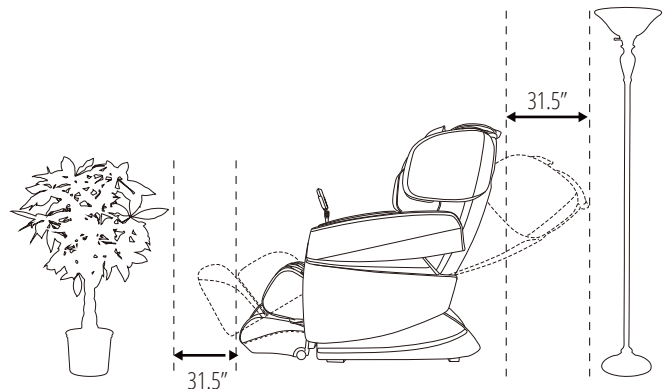

Reserve space in the front and back

CHAIR COMPONENTS

Some of your chair's most important features.

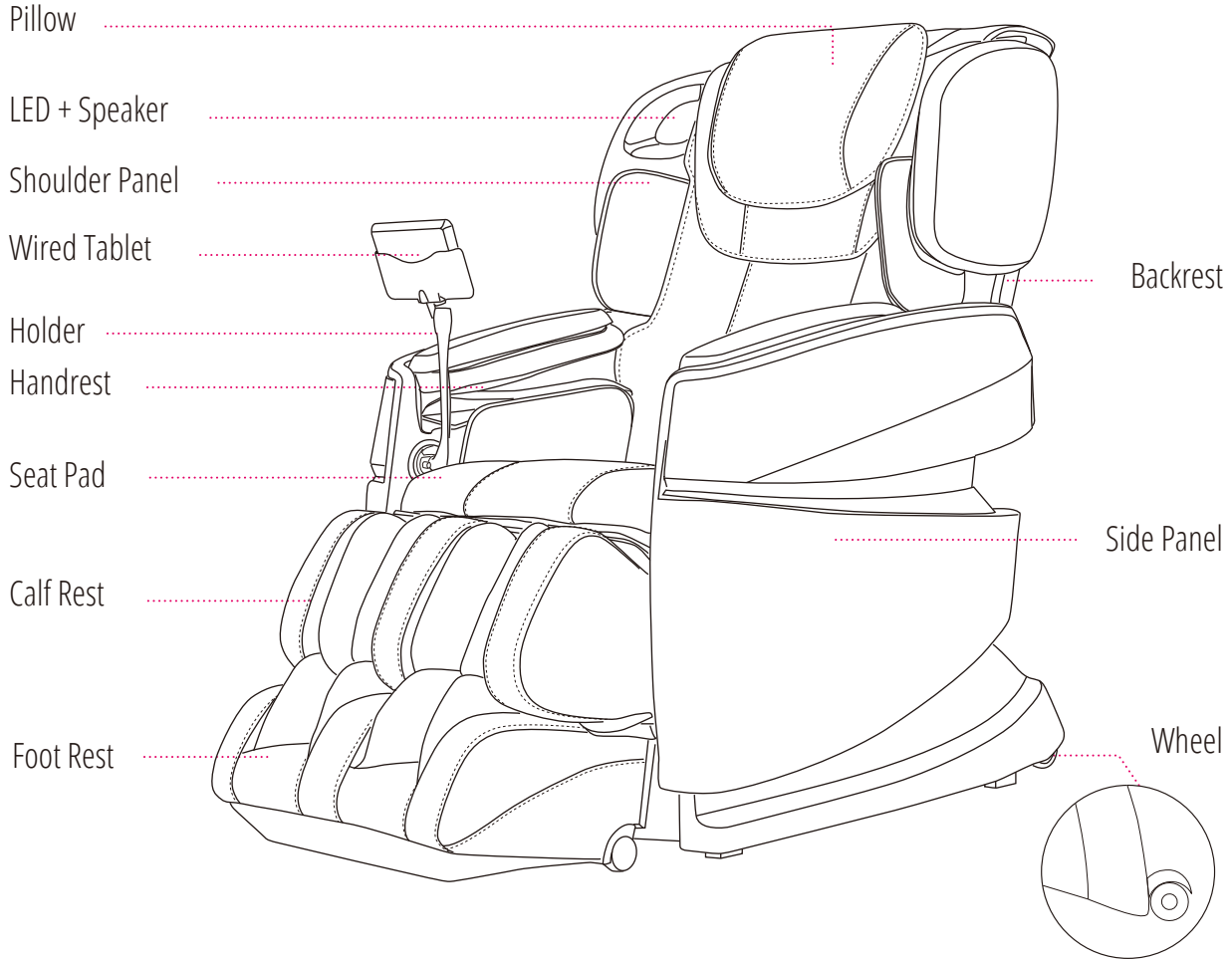

Note: The speaker will only operate when the massage chair is powered on



To play music using your massage chair's speakers please connect your smartphone, tablet, or other electronic device to your chair using bluetooth

MASSAGE POINTS

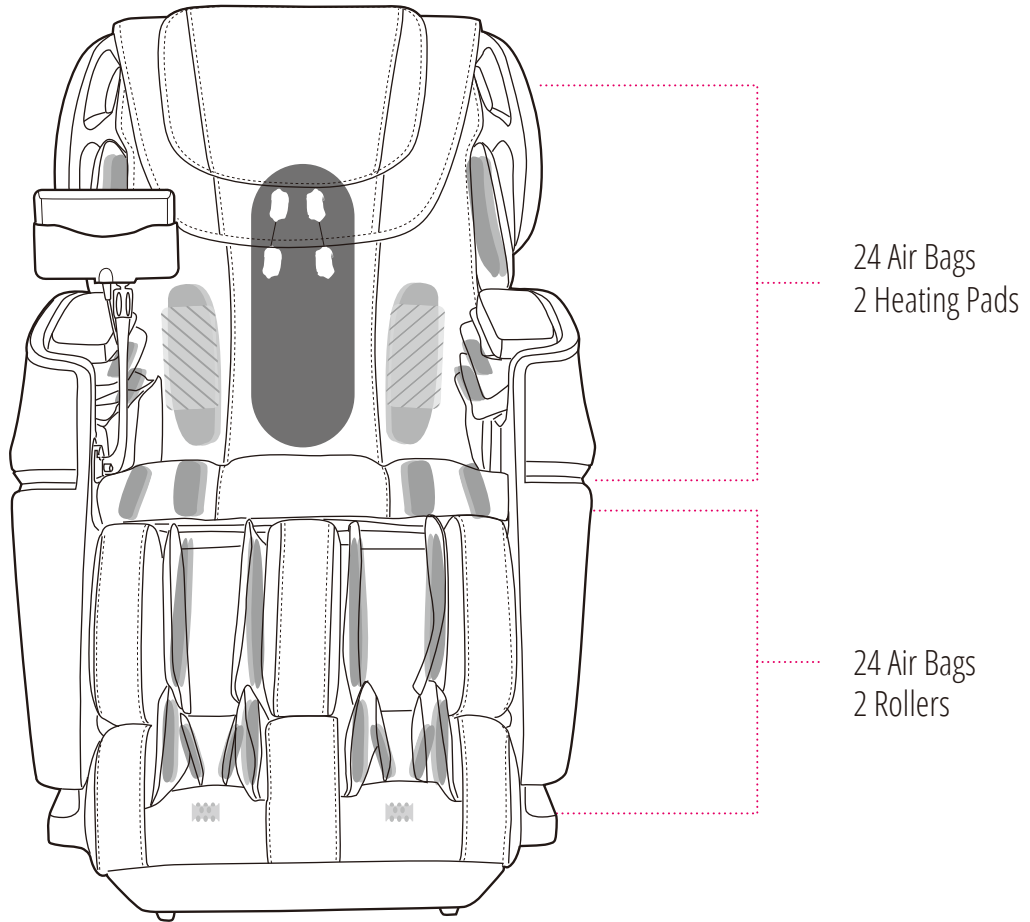

● Back Massage Mode

● Air Bag

● Heating Pad

● Roller

CHAIR SPECIFICATIONS

A few important facts about your massage chair.



Model No.

CZ-680

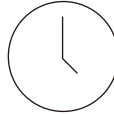

Max. Time Rate

30 minutes

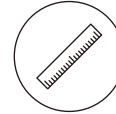

Dimensions (L x W x H)

Chair Dimension: 51.2" x 32.7" x 50.4"
Reclined Dimension: 72.8" x 32.7" x 40.6"



Shipping Weight

Gross weight: 310.8 lbs
Net Weight: 251.4 lbs

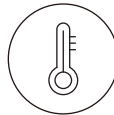

Usage Condition

Environment temperature: 10°C-40°C
Contrasting humidity: 30-85RH

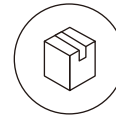

Storage Condition

Storage temperature: -20°C-60°C
Storage humidity level: 30-85RH



Power Consumption

130W



Rated Voltage/Frequency

110-120V/60Hz



Weight Capacity

350 lbs



Power of Speakers

7W (2 sides)

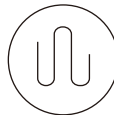

Length of Wiring

Controller wiring: 59.1"
Power supply wiring: 70.9"



Safety Feature

Equipped with overheating and power surge detectors safety feature

WIRED TOUCH-PAD INTERFACE

We have designed your massage chair's controller with a user-friendly interface to make using your chair even easier.

Home Screen

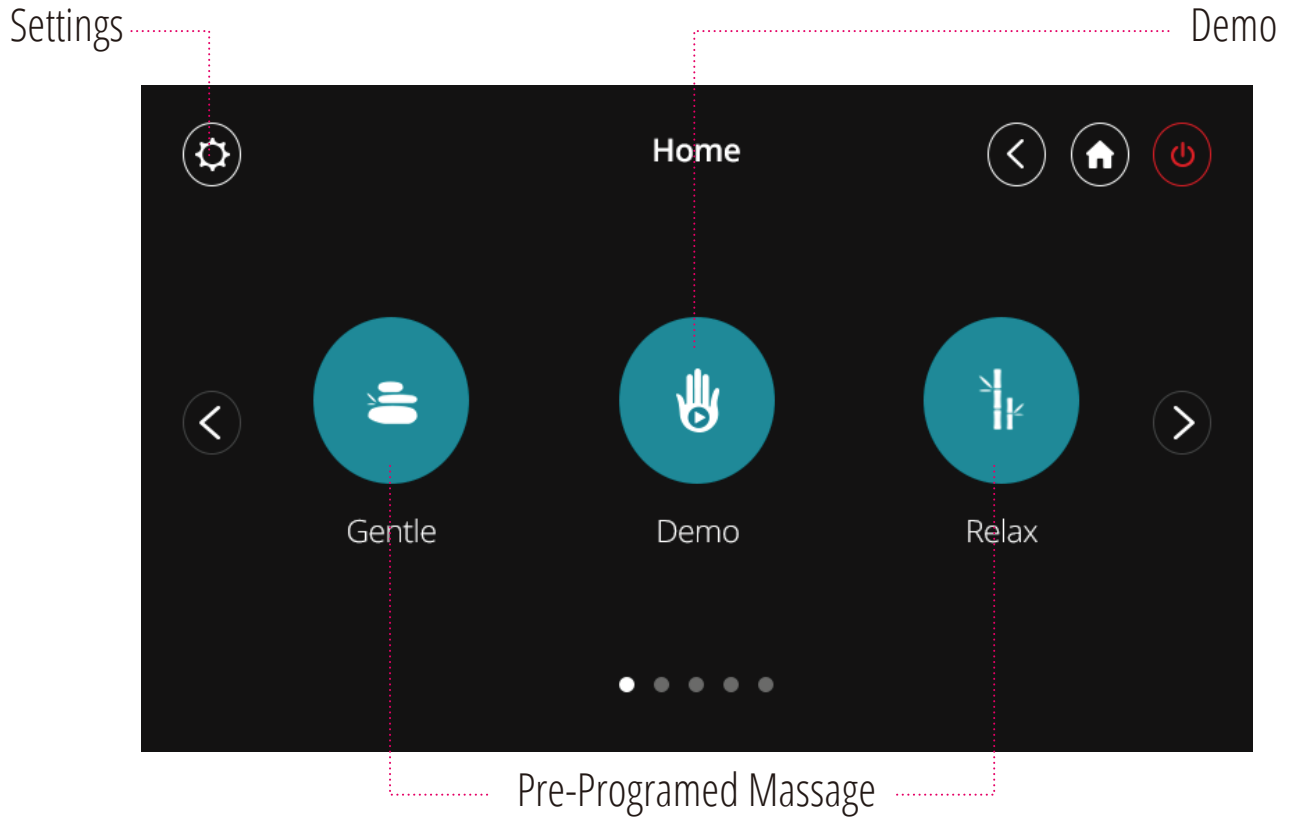

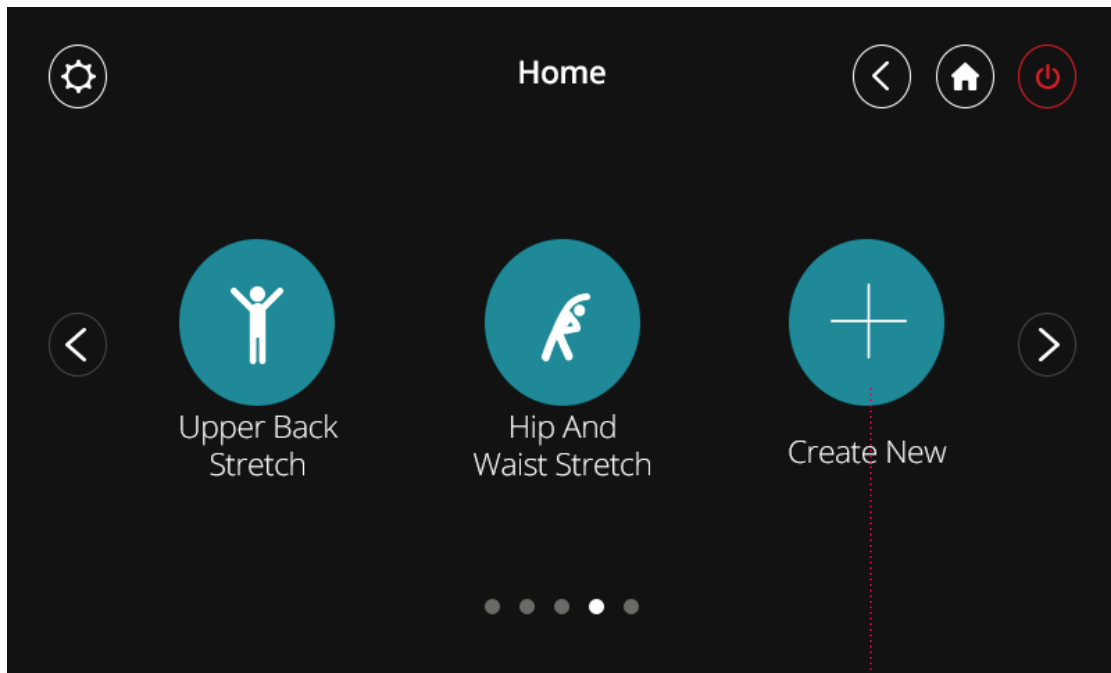

Create New Program

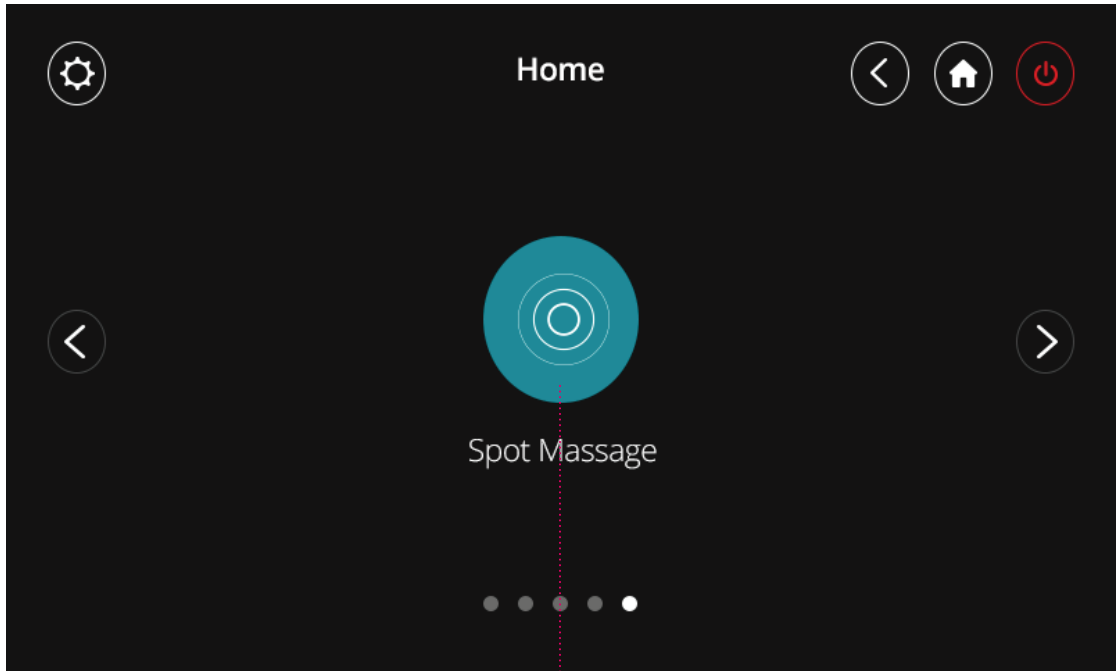

Spot Message

Spot Message

PRE-PROGRAMMED MESSAGE

We have designed your chair with multiple massage options for your changing needs. Follow these simple instructions to begin a new pre-programmed massage.

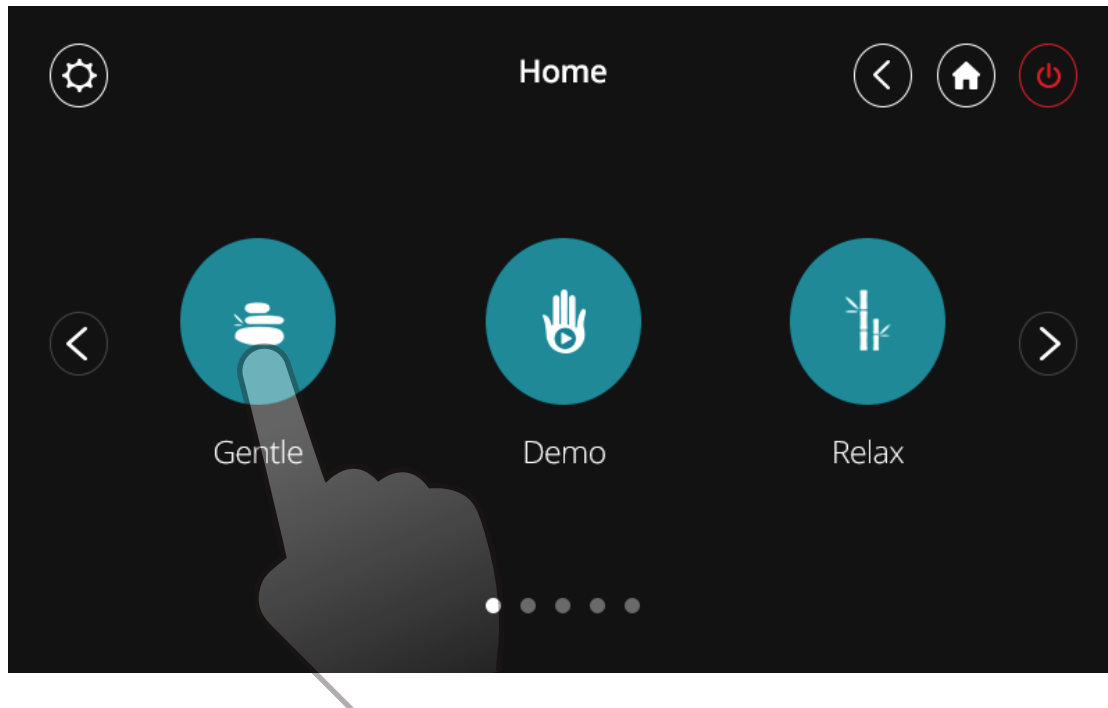

Choose 1 of our 10 pre-programmed massages
(Gentle, Relax, Therapy, Vigourous, Swedish, Japanese, Full Body Stretch, Lower Back Stretch, Upper Back Stretch, Hip and Waist Stretch)

Pre-Programmed Massage Interface



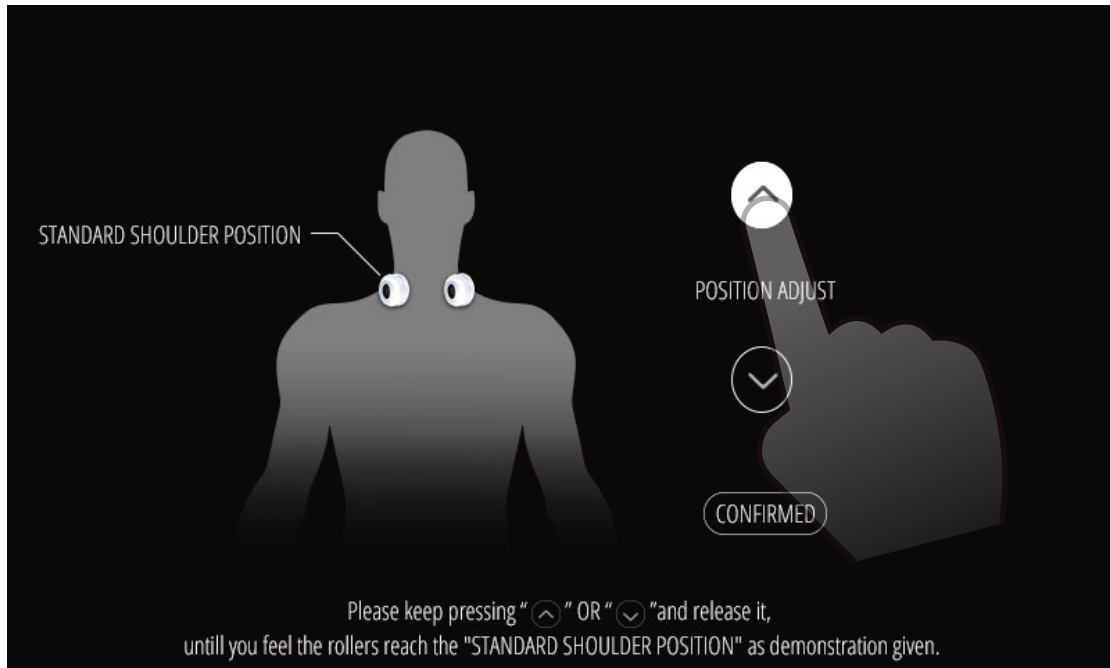

Using the arrows, you can adjust the standard shoulder position

Adjust Massage Strength Interface

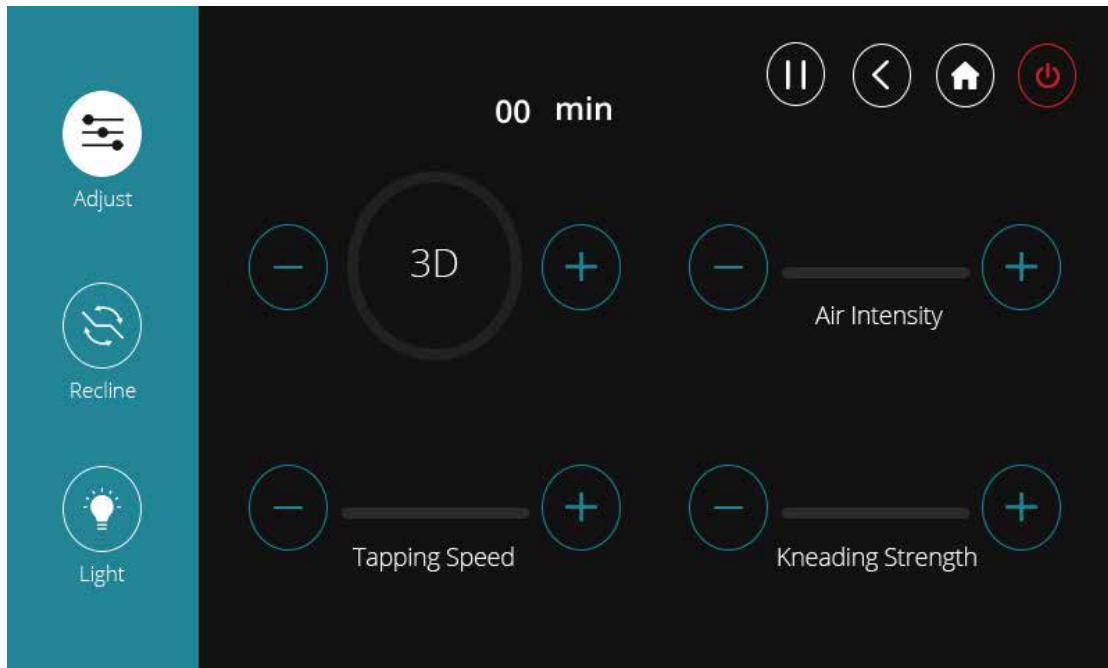

In this interface, you can adjust massage 3D strength, tapping speed, kneading strength and air intensity

Adjust Chair Angle Interface

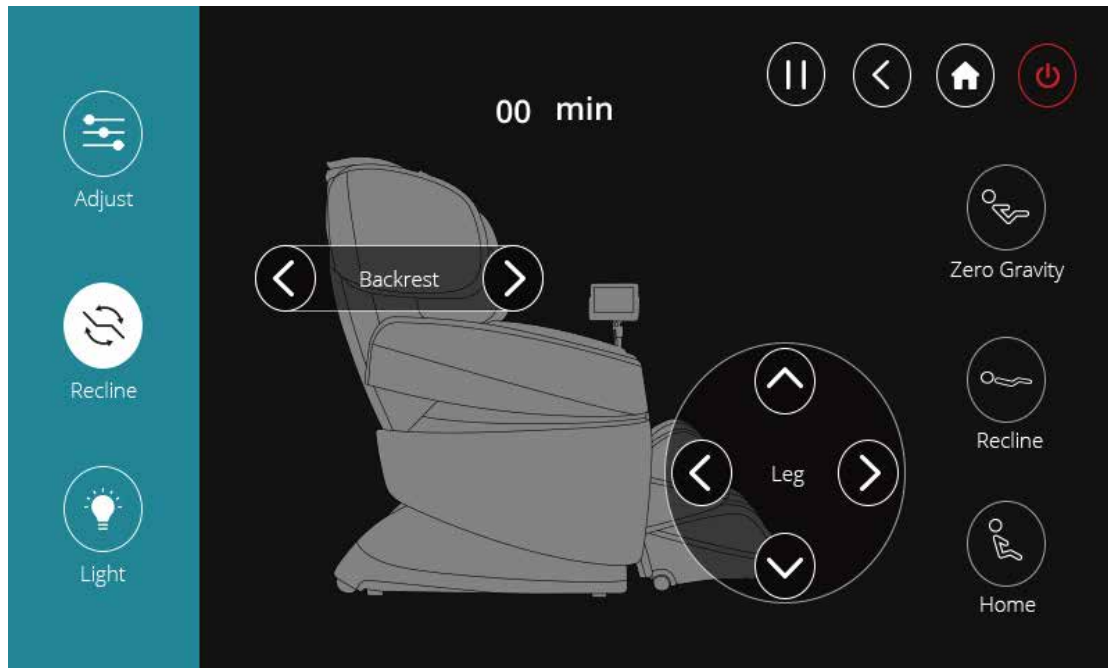

Adjust your chair quickly by choosing one of the three preset seating positions. You can also press and hold the arrows to adjust parts of the chair independently

Change the Light Interface

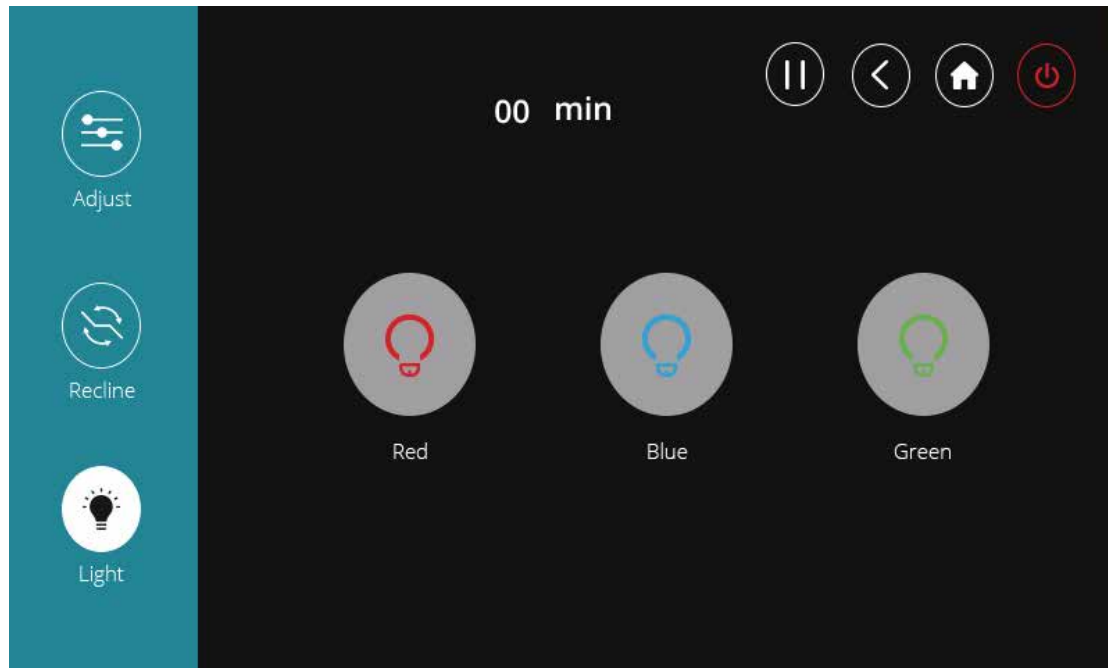

Choose 1 of the 3 types of LED light patterns

DEMO

In order to allow you to quickly understand the many features of this massage chair, we have created a demo mode for you.

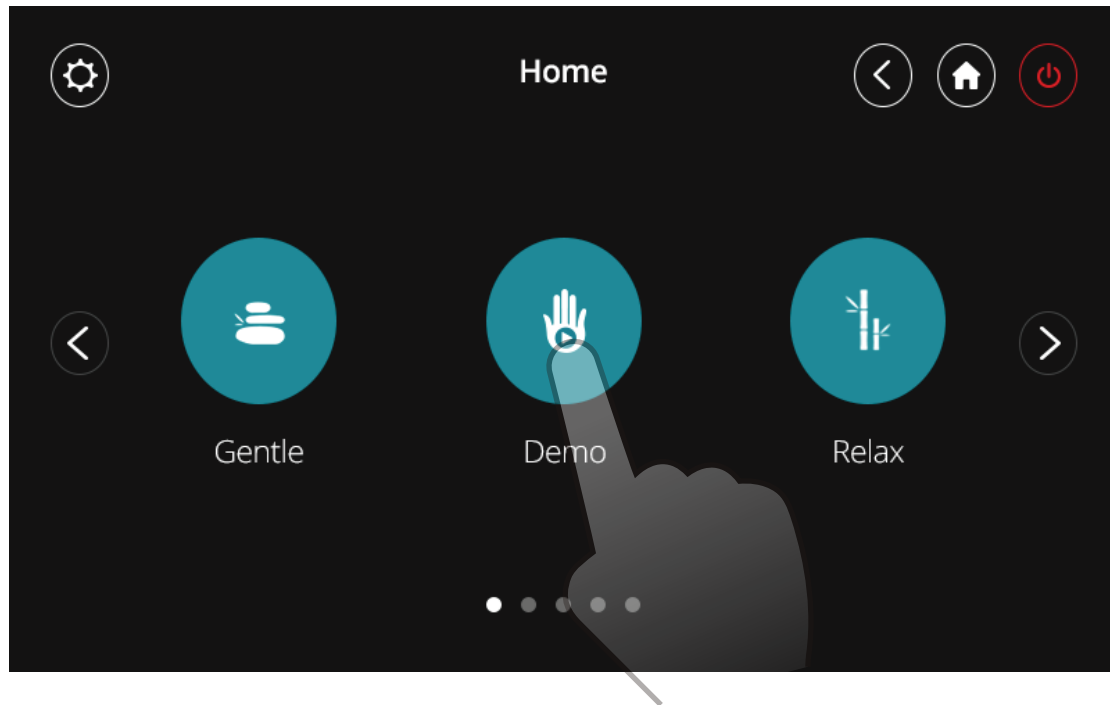

Choose the "Demo" icon to begin the demo program

Demo Interface



CUSTOM MESSAGE

Every body is different. That's why we've given you the option to customize your message to meet your specific needs. Follow these simple instructions to create a new custom message. You can create up to 3 custom programs. To delete a custom message program, press and hold the icon of the message you want to delete and choose the "x".

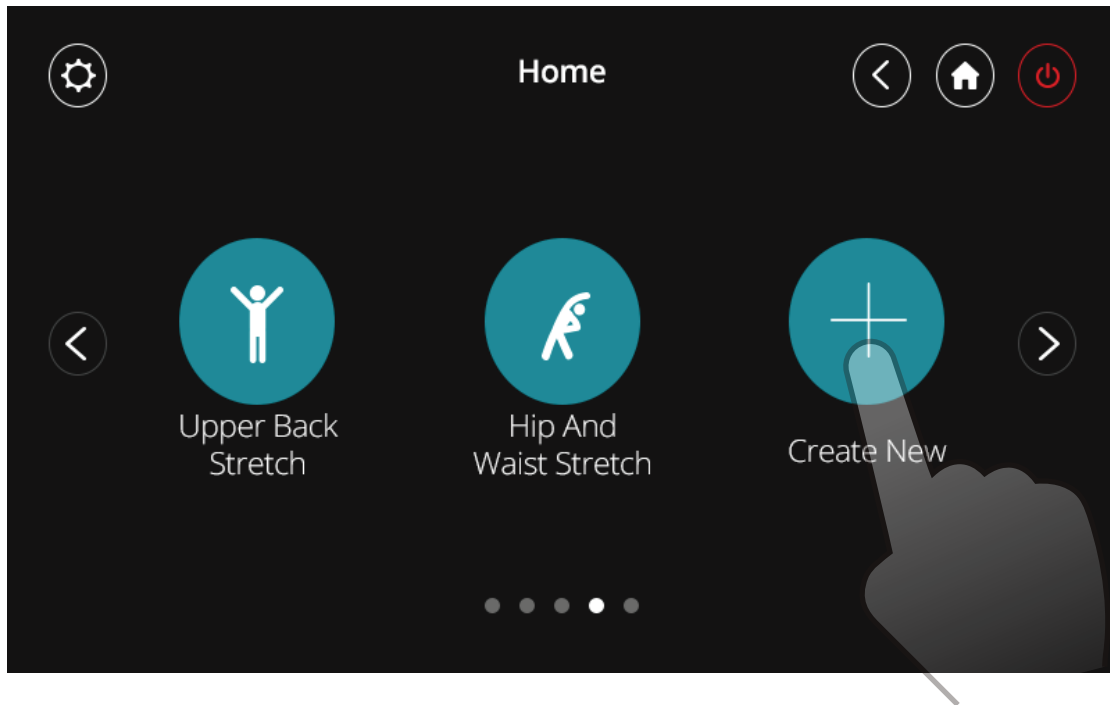

Choose the "Create New" icon to begin creating your message program

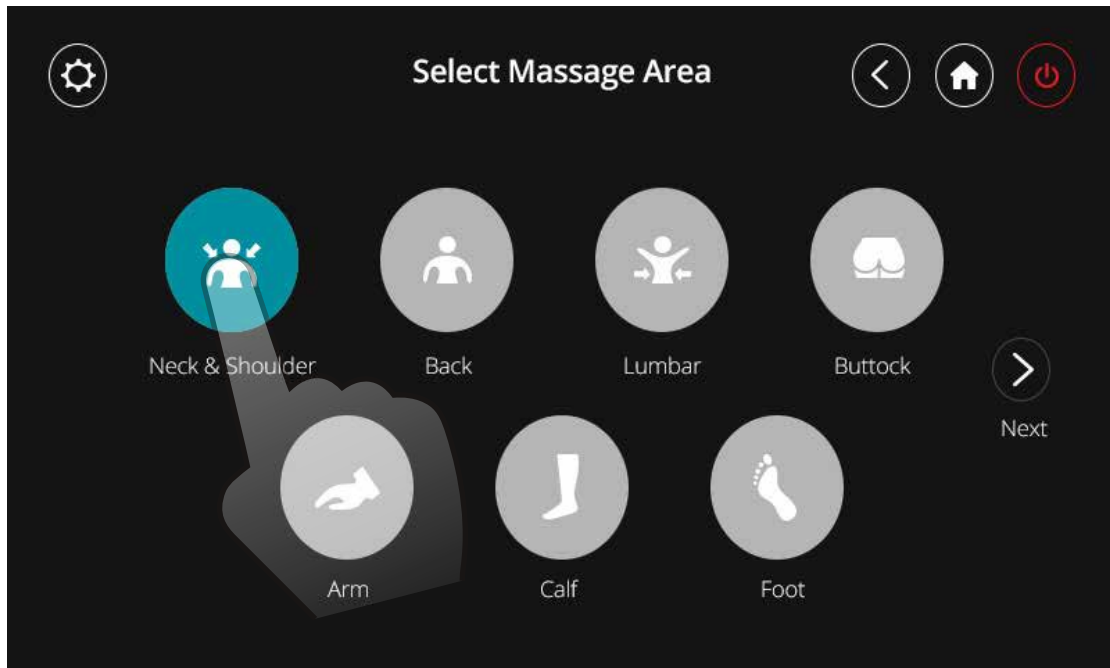

Select the massage area that you prefer

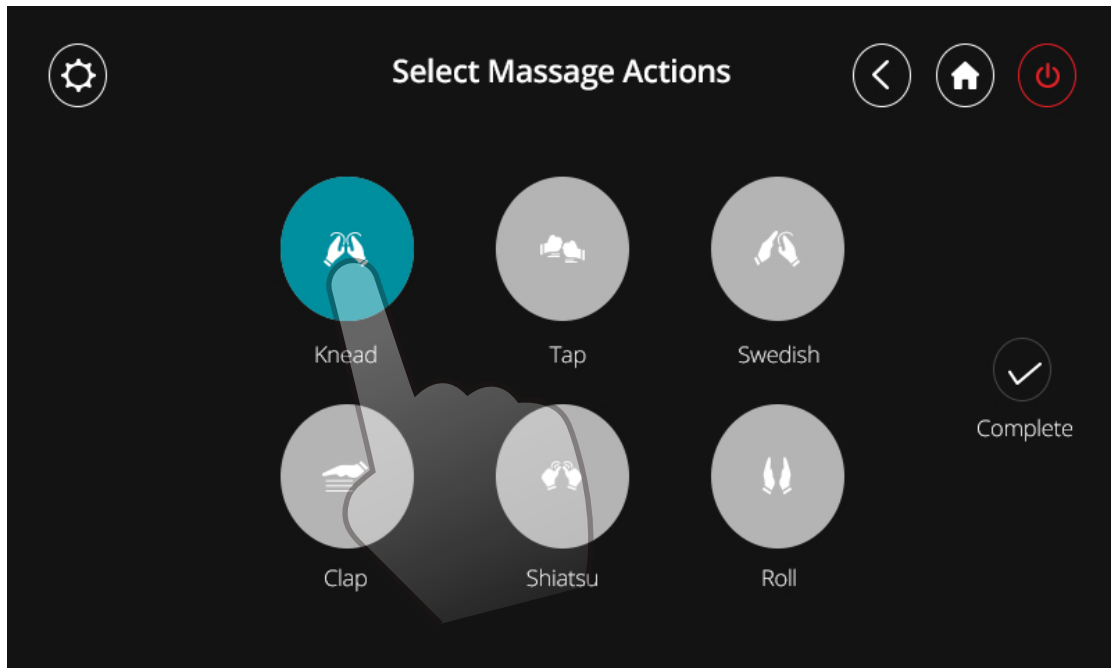

Select your favorite massage actions. The knead, tap, clap, and shiatsu massages can be combined with swedish or roll

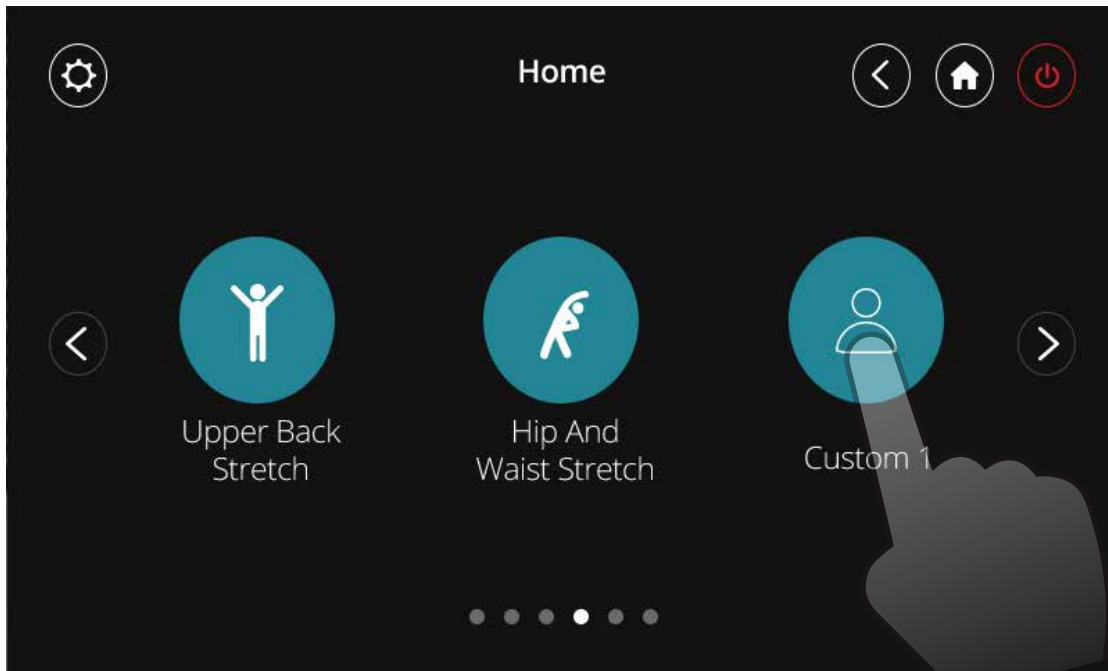

Choose the "Custom 1" icon to start your program

Custom Interface

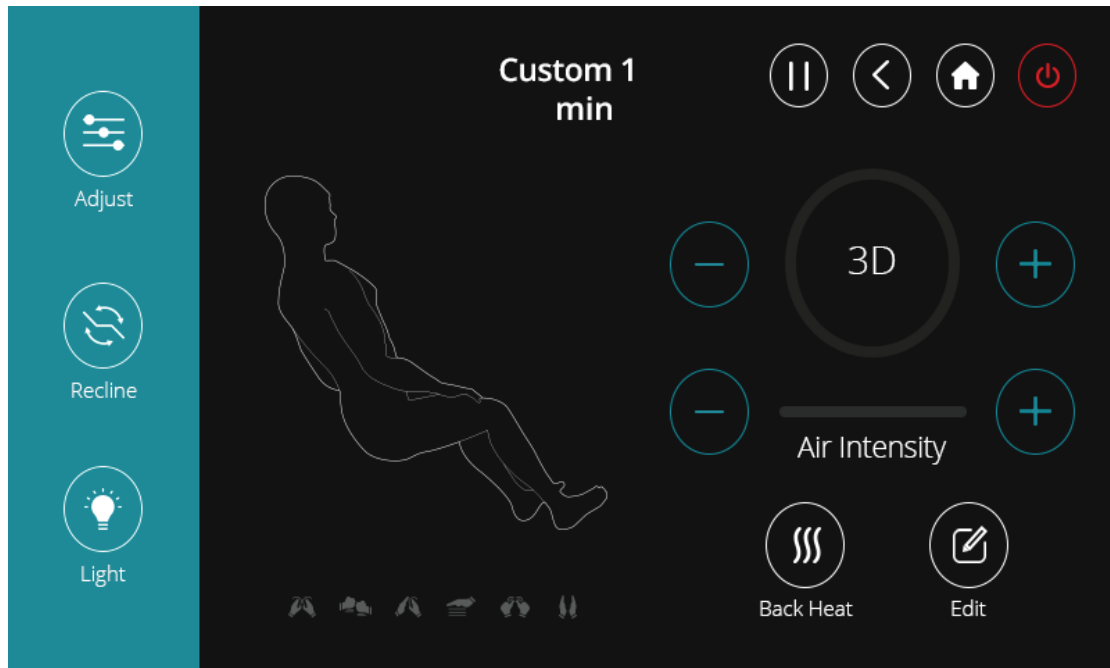

SPOT MESSAGE

This is a fixed message area and actions program.

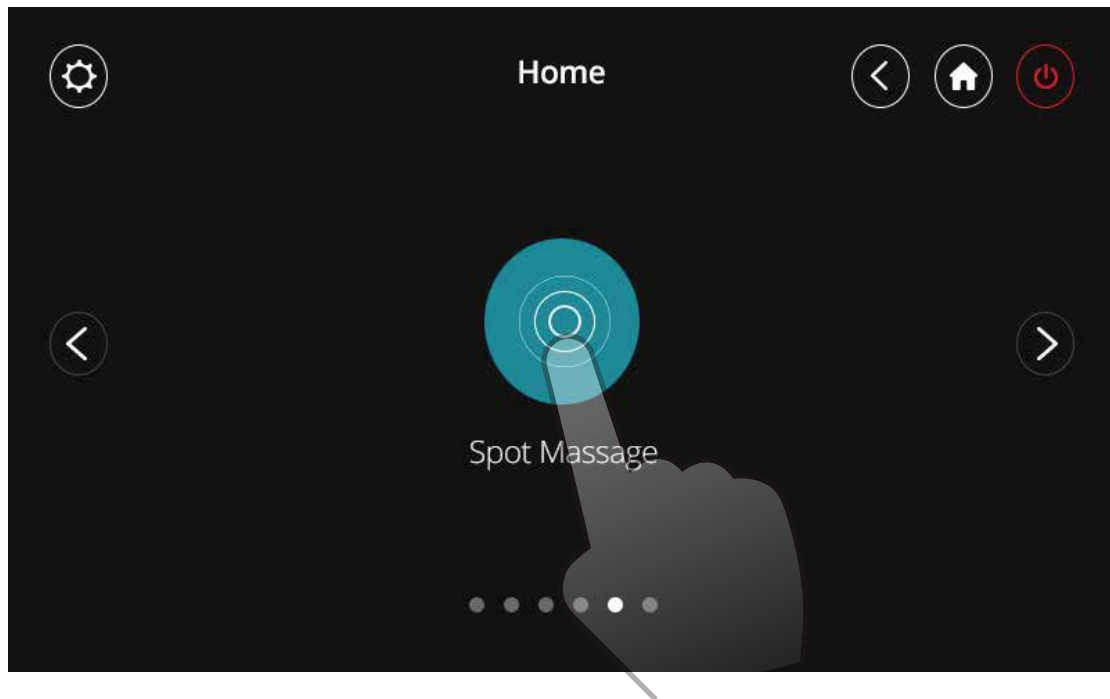

Choose the "Spot Message" button to take you to the Spot Message page

Spot Massage Interface 1



Spot Massage Interface 2

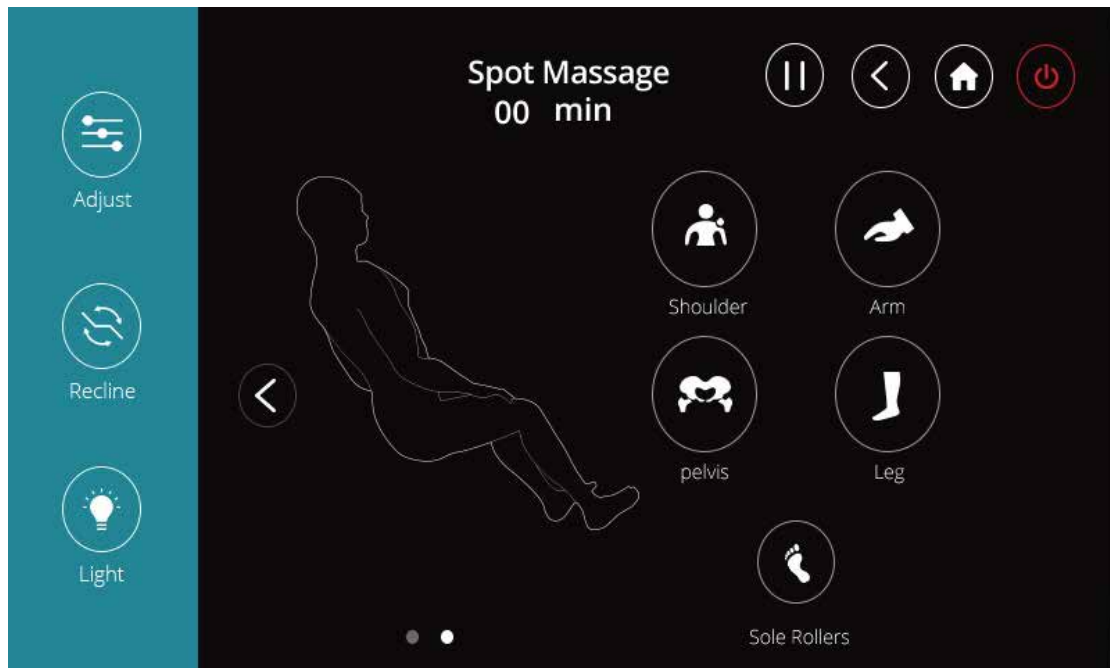

SETTINGS

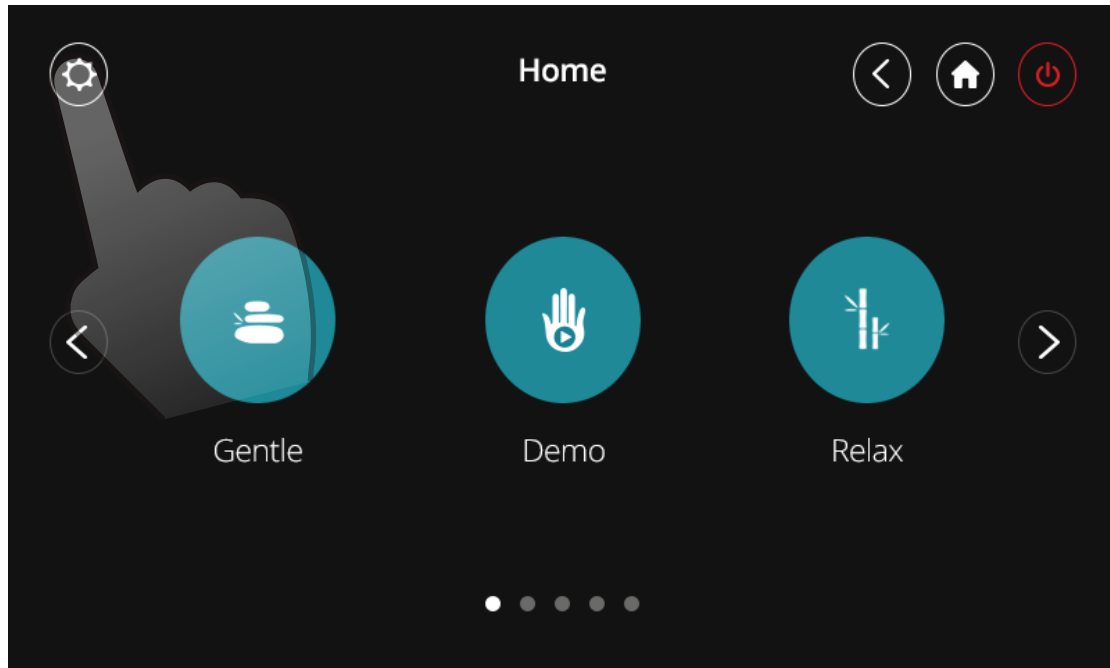

Choose the "Settings" button to take you to the settings page

Settings Interface

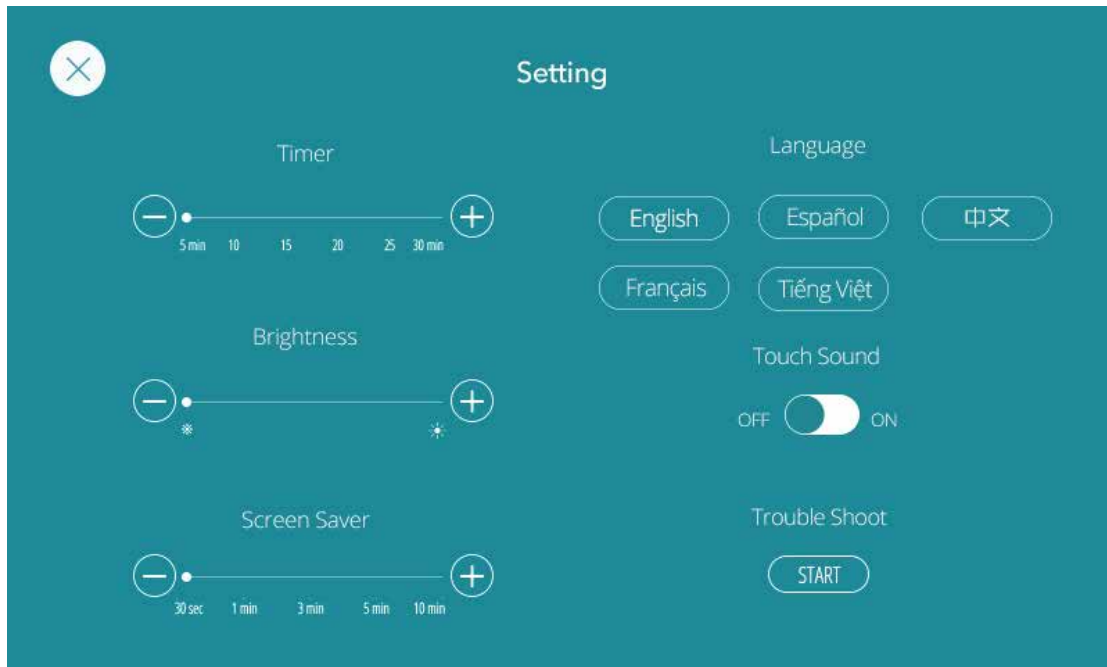

Trouble Shooting

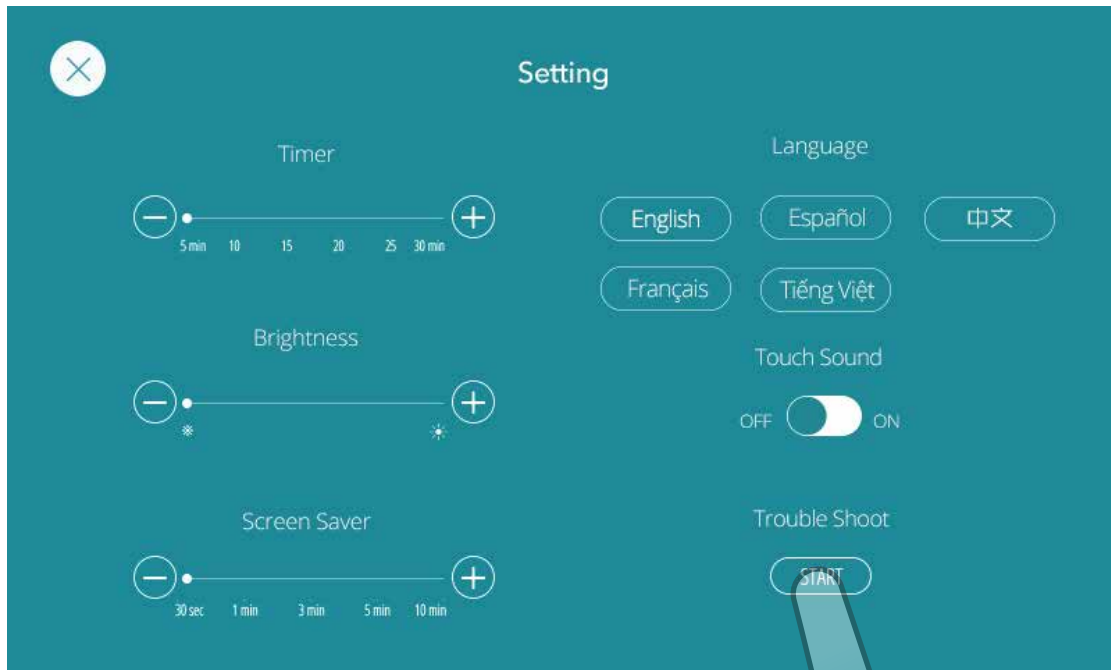

If your chair has any trouble, press the Trouble Shoot "Start" button for the chair to automatically detect problem areas. Use the error code provided when contacting our customer service team

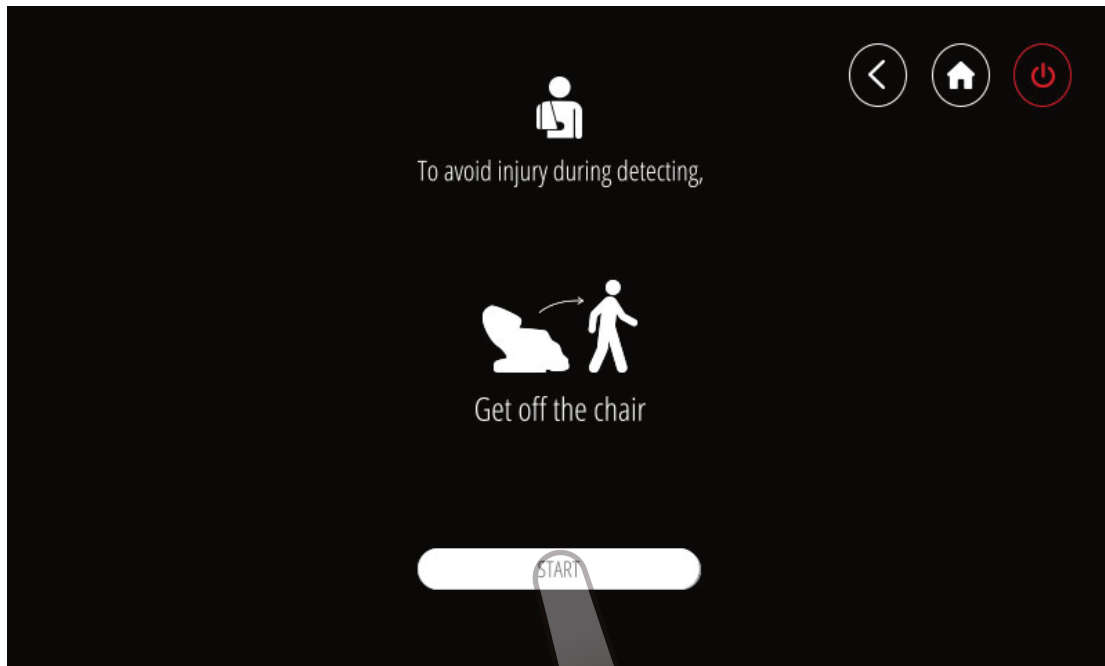

Choose "Start" button and make sure the chair is not occupied during chair detection



Your chair is detecting possible malfunctions, please wait for the detection result

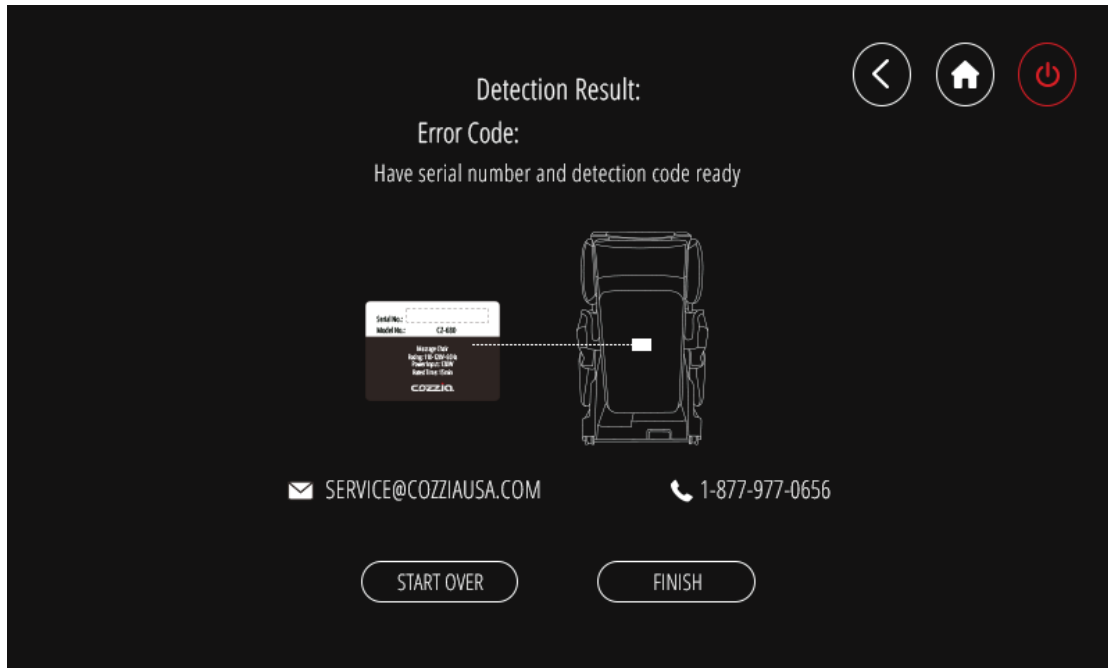

You can use your detection code when contacting the Cozzia customer service team about your chair

AUTO PROGRAM DESCRIPTIONS

Let's dig a little deeper and discover the details of our pre-programmed massages.

DEMO



A 5 minute whole body massage for those on the go.

FOCUS AREA

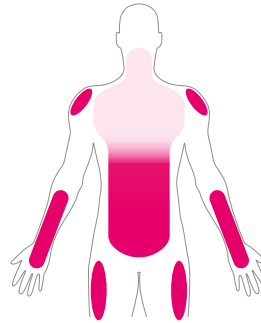

INTENSITY



FOCUS TECHNIQUE



KNEAD



ROLL

GENTLE



A program designed to provide a quiet, gentle massage that is good for beginners or those that prefer a soft touch.

FOCUS AREA

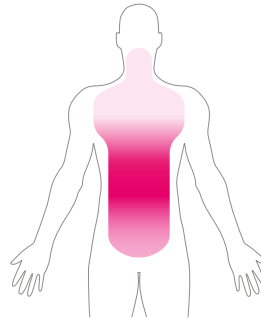

INTENSITY



FOCUS TECHNIQUE



KNEAD



TAP

RELAX

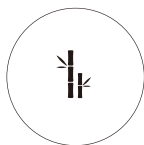

A program designed to provide a mild massage that is great for deep relaxation, best used before going to sleep.

FOCUS AREA

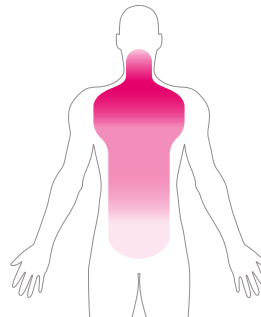

INTENSITY



FOCUS TECHNIQUE



SHIATSU



SWEDISH

THERAPY



A program designed to provide a soothing massage combined with air massage on shoulder and glutes.

FOCUS AREA

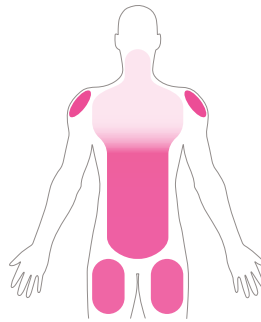

INTENSITY



FOCUS TECHNIQUE



KNEAD



CLAP

VIGOROUS



A program designed for those who enjoy a strong deep tissue massage and provides a boost of energy for users.

FOCUS AREA

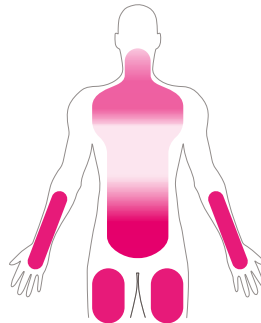

INTENSITY



FOCUS TECHNIQUE



KNEAD



TAP

SWEDISH



A program designed to use Swedish techniques to promote blood circulation to the heart, increasing oxygen in the blood and easing tension.

FOCUS AREA

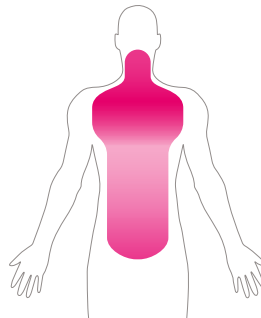

INTENSITY



FOCUS TECHNIQUE



CLAP



SWEDISH

JAPANESE



This massage will focus on your midback and upper shoulders with a deep tissue massage using the shiatsu technique, that will create an acupuncture effect.

FOCUS AREA

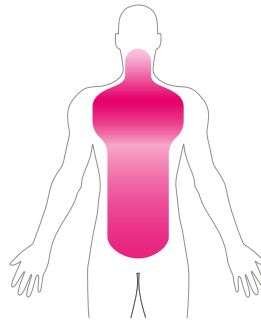

INTENSITY



FOCUS TECHNIQUE



SHIATSU



SWEDISH

FULL BODY STRETCH



This program provides you with a full body stretch, including your arm, leg, and shoulder muscles.

FOCUS AREA

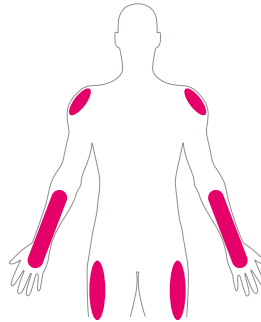

INTENSITY



FOCUS TECHNIQUE



KNEAD



ROLL

LOWER BACK STRETCH



This program provides you with a lower back stretch, focusing on your waist and leg muscles.

FOCUS AREA

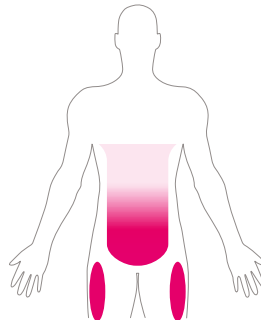

INTENSITY



FOCUS TECHNIQUE



KNEAD



ROLL

UPPER BACK STRETCH



This program provides you with an upper body stretch, focusing on your shoulder and back muscles.

FOCUS AREA

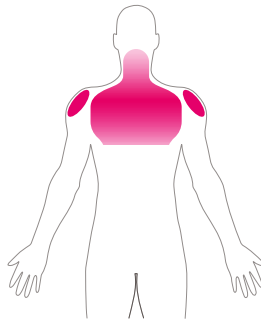

INTENSITY



FOCUS TECHNIQUE



KNEAD



ROLL

HIP AND WAIST STRETCH



This program provides you with a hip and waist stretch, focusing on your hip and waist muscles.

FOCUS AREA

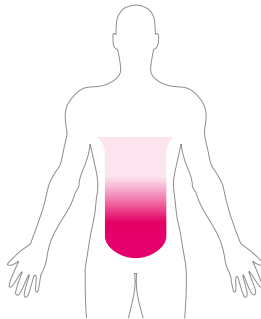

INTENSITY



FOCUS TECHNIQUE



KNEAD



ROLL

SAFETY PRECAUTIONS

We're looking out for you.

IMPORTANT SAFETY INSTRUCTIONS

When using the massage chair, basic precautions should always be followed, including the following:
Read all instructions before using this massage chair.

DANGER - To reduce the risk of electric shock:

- Always unplug this massage chair from the electrical outlet immediately after using and before cleaning.
- Never use pins or other metallic fasteners with this appliance.
- Carefully examine the covering before each use. Call for service if the covering shows any sign of deterioration, such as blistering, peeling or cracking.
- Keep dry - do not operate in a wet or moist condition.

WARNING - To reduce the risks of burns, fire, electric shock or injury to persons:

- Read all instructions before using.
- A massage chair should never be left unattended when plugged in. Unplug from the outlet when it is not in use and before putting on or taking off parts.
- Close supervision is necessary when this massage chair is used by or near children or disabled persons. Keep children away from reclining backrest and extended leg rest.
- Use this massage chair only for its intended use as described in this manual.
- Never operate this massage chair if it has a damaged cord or plug, if is not working properly, if it has been dropped or damaged, or dropped into water. Contact customer service department.
- Keep the cord away from heated surfaces.
- Never operate the massage chair with the air openings blocked. Keep the air openings free of lint, hair and the like.
- Never drop or insert any object into any opening.
- Do not use outdoors.
- Do not operate where aerosol (spray) products are being used or where oxygen is being administered.
- To disconnect, turn all controls to the off position, then remove the plug from the outlet.
- Do not stand on or in the massage chair. Use only while seated.
- The product is not intended for use by children or persons with reduced physical, sensory or mental capabilities, or lack of experience and knowledge, unless they have been given supervision or instruction concerning use of the product by a person responsible for their safety.
- Children should be supervised to ensure that they do not play with the product.
- Temperatures sufficiently high to cause burns may occur regardless of the control setting. Do not use on an infant or invalid or on a sleeping or unconscious person. Check the skin in contact with the heated area of the appliance frequently to reduce the risk of blistering.
- Burns may result from improper use.
- Do not crush in order to avoid sharp folds.
- Keep children away from extended foot support (or other similar parts).
- DO NOT WET.
- DO NOT USE PINS.
- NEVER REMOVE COVER.
- Connect this appliance to a properly grounded outlet only. See Grounding Instructions.

SAVE THESE INSTRUCTIONS

This massage chair is intended for household use only.

1. Usage Environment

- Do not use the massage chair in an excessively humid or dusty environment as this may result in malfunction or electric shock.
- Do not use the massage chair in a room with a temperature of 104°F or higher.
- Do not expose the massage chair to heaters, stoves or direct sunlight.
- Place and use the massage chair on an even, non-slip floor.
- The massage chair is designed for home use and not for commercial purposes.



Caution

- This massage chair is to be used indoors only.
- If you use the massage chair in a cold room, do not increase the room temperature abruptly. It is recommended that you increase the temperature gradually to a normal level.
- If the massage chair is stored in a cold place and is being brought into a warm environment, it is advisable to wait for one hour before use. This is because its performance may not be at an optimal level, as there may be water droplets on the mechanical parts due to condensation. Using the massage chair under such conditions may result in malfunction.

2. Safety Precautions

- To ensure safe and correct use of the massage chair, do not operate it without reading this operation manual carefully.
- Do not use the massage chair when the upholstery or seat is removed. This may cause injury or malfunction.
- Do not use the massage chair in combination with other therapeutic equipment or electric blanket etc., as this may result in ineffectiveness or injury.
- Do not use the massage chair an hour before or after eating as this may have adverse effects on the user.
- Do not allow children or pets to play around the massage chair, e.g. behind the backrest, under the seat base or legrest of the massage chair. This may result in injury.
- Do not use the massage chair when your body is wet.
- Do not operate the massage chair with wet hands.
- It is not recommended to use the massage chair for more than 30 minutes.
- Do not perform continuous massage on the same spot of your body for more than 5 minutes at a time as this may result in excessive stimulation and may have adverse effects.
- Do not insert your hand or foot along the paths of the massage rollers during use as this may cause injury.
- Stop operation immediately if you feel any discomfort.
- This product is not intended for self-treatment of conditions that should be managed by a qualified health care provider.
- People on medication or with medical conditions, please consult your doctor before use.
- Please do not use the product if you are not feeling well.

3. People with Medical Conditions

Consult your doctor before use if you:

- Are under medical rest as ordered by a doctor.
- Have spinal disorders, an abnormal spinal condition or have suffered a spinal injury.
- Have back problems.
- Have diabetes, osteoporosis or sensory impairment.
- Have joint dysfunction such as rheumatism, hammertoe or gout.
- Have a pacemaker or other electronic medical devices.
- May be pregnant.
- Have phlebitis or thrombosis.
- Have an increased risk for blood clots.
- Had recent surgery.
- Have surgical pins, screws, or anything mechanical in the legs, ankles or feet.



Caution

- This massage chair is not intended for use by children or persons with reduced physical, sensory or mental capabilities, or lack of experience and knowledge, unless they have been given supervision or instruction concerning use of the massage chair by a person responsible for their safety.
- Children should be supervised to ensure that they do not play with the massage chair.
- Avoid using the massage chair under the influence of alcohol.
- Do not apply massage rollers directly on the head, elbow or knee joints, torso or abdomen.
- If your legs or feet slip off the leg rest during massage, do not force them back in as this may result in injury.
- Remove the power plug from the electrical outlet immediately should liquid be accidentally spilled onto the massage chair. Do not use wet hands to connect or disconnect the power plug from the electrical outlet.
- Do not tamper with the power cord or use the massage chair with a damaged cord as this may result in malfunction and electric shock.

4. Instances When the Massage Chair Should Not Be Used

In the following events, please switch off the main power switch immediately and disconnect the power cord from the electrical outlet:

- If liquid is accidentally spilled onto the massage chair. This may result in electric shock or malfunction.
- If the fabric of the backrest is torn and the internal components are exposed.
- If pain or discomfort is felt during massage, stop operation immediately and consult your doctor.
- If you detect any malfunction or any other abnormal condition during operation.
- If there is power failure. Injury may occur when power is restored unexpectedly.
- If there is lightning.

5. Assembly and Repair of the Massage Chair

- Do not disassemble the backrest cover of the massage chair. Touching the internal components may result in malfunction or electrical shock.
- This massage chair must only be professionally serviced or repaired. Only disassemble or repair the massage chair if directed by a Cozzia service rep.

6. Things to Be Noted About the Power Plug and Cord

- Check that the Alternating Current (AC) voltage corresponds with the specifications indicated for the massage chair.
- Do not connect or disconnect the power plug from the electrical outlet with wet hands. This may result in malfunction or electric shock.
- When disconnecting the power plug, pull it by holding the plug, not the cord.
- Although operation will be stopped automatically by the Auto-Timer function, always remember to switch off the main power after use.
- Do not place the power cord under the massage chair or on any other heavy objects.
- Do not wind the power cord around the massage chair as this may damage the cord and result in a fire or electric shock.
- Do not operate the massage chair with a damaged cord or extension cord.
- Do not use the massage chair if the electrical outlet is loose.
- If the power cord is damaged, it should be replaced by a qualified technician.

GROUNDING INSTRUCTIONS

This product must be grounded. If it should malfunction or break down, grounding provides a path of least resistance for the electric current to reduce the risk of electric shock. This product is equipped with a cord that has an equipment-grounding conductor and a grounding plug. The plug must be plugged into an appropriate outlet that is properly installed and grounded in accordance with all local codes and ordinances.

Danger - Improper connection of the equipment-grounding conductor can result in a risk of electric shock. Check with a qualified electrician or service technician if it will not fit in the outlet. Have a proper outlet installed by a qualified electrician.

This product is for use on a standard 120V circuit and has a grounding plug that looks like the plug illustrated below. Make sure that the product is connected to an outlet having the same configuration as the plug. No adapter should be used with this product.

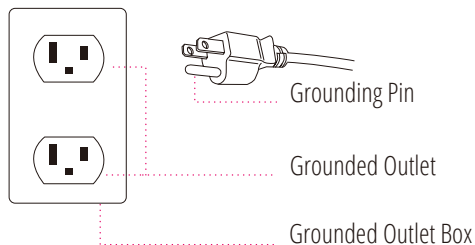

TROUBLESHOOTING

This massage chair is controlled by a microcomputer and is thus susceptible to power surges of +10 to - 15%. The following situations may arise in the event of a power surge:

Situation	Solution
The massage chair is connected to the power supply but is not functioning	<ol style="list-style-type: none">1. Check to see that the plug is properly connected and working2. Ensure the massage chair switch is in the 'I' position
The remote control works but the massage chair is not functioning	Possible overheating due to prolonged use. Turn off the power for at least 30 to 50 minutes
Both the remote control and the massage chair are not functioning	<ol style="list-style-type: none">1. Ensure the chair is plugged into a working outlet2. Turn the power OFF and ON again

If you continue to have problems, please read the warranty card and contact the Cozzia service department.

PRODUCT CARE AND STORAGE

1. Storing the Massage Chair

- Wipe off dust and dirt from the massage chair with a dry, soft, clean cloth after use.
- Keep the massage chair clean and away from places of high humidity.
- If the massage chair is not to be used for a long period of time, cover the massage chair with a dust cover and unplug its power plug from the electrical outlet.

Caution

- Do not store the massage chair in direct sunlight or in places of high temperature. This may cause the color of the upholstery to fade.
- Do not allow the massage chair to remain in contact with vinyl or wallpaper for extended periods of time as this could lead to discoloration.

2. Cleaning the Massage Chair

- Before cleaning, ensure that the main power switch is off and the power plug is disconnected from the electrical outlet.
- Wipe off dust and dirt from the massage with a dry, soft, clean cloth after each use.
- This product can be cleaned thoroughly with a slightly damp cloth.
- Do not iron the upholstery.
- Do not wash the upholstery using a home washing machine as this may result in deterioration of the upholstery's quality.

Caution

- Do not use abrasive cleaning agents like benzene or thinner to clean the massage chair. This may cause the upholstery to fade.

3. Cleaning the Controller

- Use only a clean, dry cloth to clean the controller.

Caution

- Do not use a wet cloth to clean the controller. This may result in malfunction.

Product Repairs

- Floor Models and Demonstration Units have a prorated warranty period that begins the day the model is placed on the floor and connected to an electrical outlet by the retail partner. Proof of purchase is required in order to obtain warranty service and parts. Non-warranty parts and service are available at a “per incident” charge.
- Warranty Coverage Period - Warranty coverage starts at the time that the consumer PURCHASES their chair. Proof of purchase is required for all warranty repairs. The warranty time period is measured by continuous calendar days based on a seven-day week.
- Field Service - Cozia customer service department will diagnose and schedule an authorized service provider to repair the chair in the consumer's residence.
- Parts - All parts deemed necessary for repairs will be shipped to the consumer at no charge by the Cozia service department. Some Cozia product repairs may be performed by the consumer in their own home with parts and instructions supplied by Cozia, such as remote controller replacements that don't require a technician.

CONSUMER WARRANTY LIMITATIONS AND EXCLUSIONS

- Warranties are only valid in the 48 contiguous United States and Canada and are contingent upon the consumer operating the chair according to the corresponding instruction manual.
 - The warranty only applies to Cozia products and does not include any accessories or enhancements.
 - Field service requires pre-approval and must be performed by Cozia's authorized field service personnel.
 - Field service is only available in the United States and in major metropolitan areas in Canada.
 - Softening of foams and filling composites in pillows, pads, and memory foam occurs naturally and does not constitute a defect under this warranty.
 - Fading, wear and piling of fabrics occurs naturally and does not constitute a defect under this warranty.
 - Warranties do not cover any loss or damage resulting from improper installation, unauthorized repairs or modifications, improper use of electrical/power supply, loss of power, dropped product, a malfunction or damage of an operating part from failure to provide manufacturer's recommended maintenance, transportation damage, theft, abuse, misuse, neglect, vandalism or environmental conditions (fire, floods, rust, corrosion, sand, dirt, windstorm, hail, earthquake or exposure to weather conditions), loss of use during the period the product is at a repair facility, or loss of use during the period the product is awaiting parts or repair.
 - Damage due to personal shipping and handling does not constitute a defect under this warranty.
 - Under no circumstance shall Cozia or its representatives be liable for indirect, consequential, or incidental damages (including damages for lost profits, business interruption, bodily injury, medical and the like).
 - Warranties are non-transferable.
 - Cozia's sole liability and the purchaser's exclusive remedy shall be for the repair, or at Cozia's option, for the replacement of the defective part.
 - Notwithstanding the above, if replacements parts for defective materials are not available, Cozia reserves the right to make substitutions in lieu of repair or replacement.
-
- All warranties begin on the DATE OF PURCHASE; no allowance or extension is offered for delivery and/or installation.
 - Warranties do not apply to rental, business, commercial, institutional or other non-residential users.