



Gemini Max

The Gemini Max is the pinnacle of premium seating design incorporating years of spectator seating experience to provide the most advanced seat at the most cost effective price. The Gemini Max is a hybrid of a more advanced beam mount design mixed with the best aspects of traditional VIP spectator seating, with Gemini Max you get the best of both worlds. Designed with ergonomics in mind the Gemini Max is unrivaled in comfort while supplying the most leg room and widest egress pathways of any spectator seat in the market. Equipped with a higher and thicker padded back than the standard Gemini, the Gemini Max is truly a seat designed for the maximum luxury experience.

Features

- 1** Available With a Full Clam Shell Fold or $\frac{3}{4}$ Safety Fold Seat
- 2** Available With Fully Upholstered Gemini Max Arm With Optional Integrated Front or Rear Cup Holders
- 3** Power Rail Available With USB, USBc, and Traditional Power Outlets
- 4** Available With Tek Arm With USB and Optional Wireless Qi Charging
 - Available Fully Upholstered or With Plastic Seat Bottom and Back Shells, Acoustic Seat Bottom Available Upon Request
 - Fixed Rear Mount Cup Holder and Tip Up Cup Holder Available
 - 39" High Back With Added Padding
 - Beam Mount Design Provides Ease of Install, Maintenance, and on Site Flexibility
 - Indoor and Outdoor Options Available
 - Seat Foam Density and Softness Fully Customizable to Your Needs
 - Adjustable Seat Widths From 22"-24" Wide
 - Seat Numbers and Row Letters Available
 - Available in Both Tread Mount and Nose Mount Retractable Designs

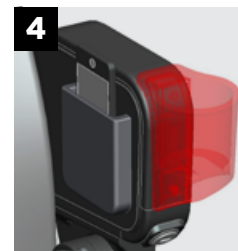
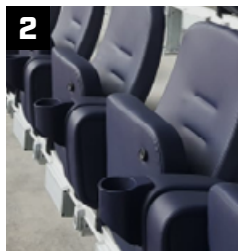

Specifications

- Back Height: 39"
- Seat Width: 22" - 24"

Gemini Max Options and Add-Ons

Available Finishes



Plastic Shell



Fully Upholstered



Acoustic

Tek Arm With USB & Wireless Qi Charging

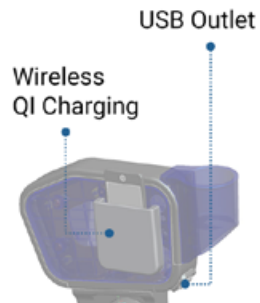
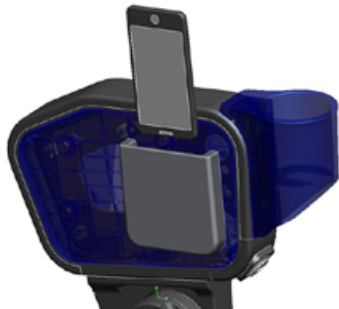

Wireless Qi Charging is Optional

Armrest Cup Holders

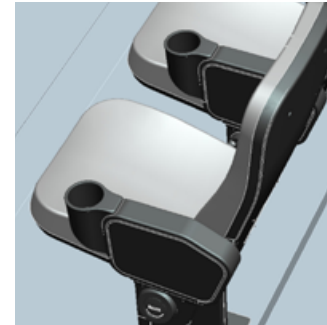

Front Armrest Cupholder

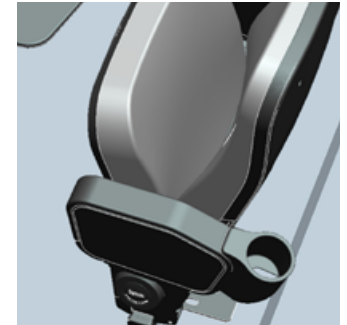

Rear Armrest Cupholder

Rear Cup Holders



Fixed



Tip-Up Cup Holder

Telescopic Application

Available in both tread mount and nose mount retractable seating designs.



Tread Mount

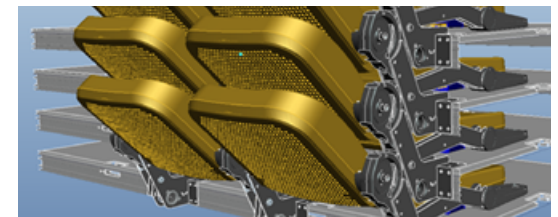

Nose Mount

Gemini Temperature Controls

Your Choice of a Cooled or Heated Seat Bottom with a Dual Mode, HML Side Control

The Thermavance system uses conductive cooling and heating. It does not use circulated air to create the cooling/heating effect on the occupant's bottom.

The system does not require air movement through the cover which means it doesn't require perforations in the seat surface material. Therefore, because the seat cover is sealed, it is weather-friendly and spill-friendly.

 **Weather Friendly**

 **Spill Friendly**

 **Play Video**

