

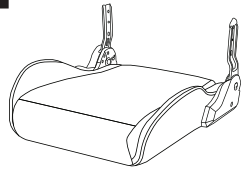

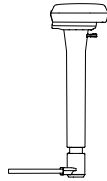

Xpression PRO Gaming Chair

Assembly Instructions // For any questions, please call us at 631.656.1066 or email Info@Zipchair.com

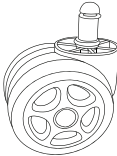
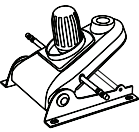
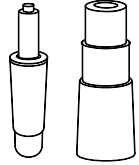
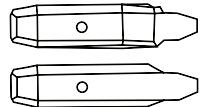
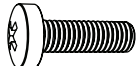

<p>A</p>  <p>Seat Back x1</p>	<p>B</p>  <p>Seat Bottom x1</p>	<p>C</p>  <p>Armrest x2</p>
<p>D</p>  <p>Base x1</p>	<p>E</p>  <p>Wheels x5</p>	<p>F</p>  <p>Tilt Mechanism x1</p>
<p>G</p>  <p>Gas Lift & Cover x1</p>	<p>H</p>  <p>Recliner Mechanism Covers x2</p>	<p>I</p>  <p>Screws (Pre-Attached)</p>
<p>J</p>  <p>Universal Tool x1</p>	<p>K</p>  <p>Cover Caps x2</p>	<p>L</p>  <p>Screws (Pre-Attached)</p>
<p>M</p>  <p>Head and Back Pillow Set x1</p>	<p>N</p>  <p>Adjustment Handles x2</p>	<p>O</p>  <p>Optional: Logo Panel x1</p>

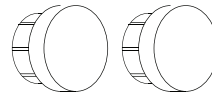
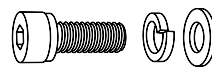
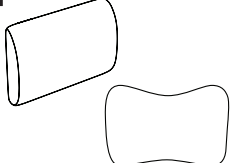
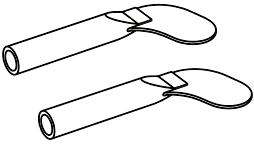
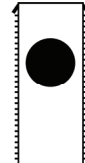
Step 1

Bolts shown are already attached to chair at delivery.

Remove bolts, align arms on seat bottom, and attach bolts as shown in the diagram.

Arms are labeled with R and L decals for right and left position placements.

Note: Make sure bolts are secured tight, should be flush to the chair.

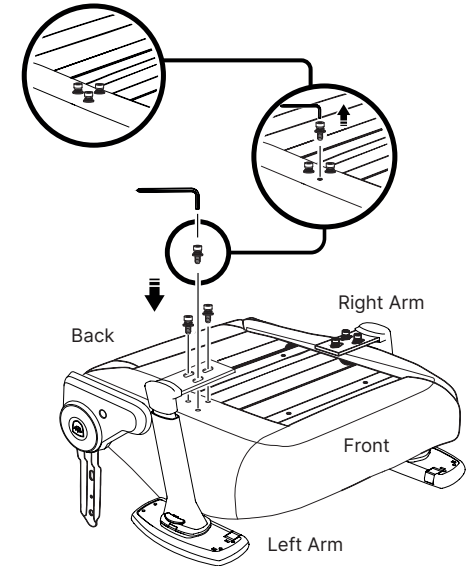
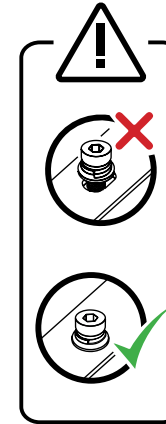

Step 2

Align seat back to side brackets already attached to the seat bottom.

Important: Attached right side of chair to seat bottom first.

Do not tighten until chair is fully assembled. Tighten evenly on each side.

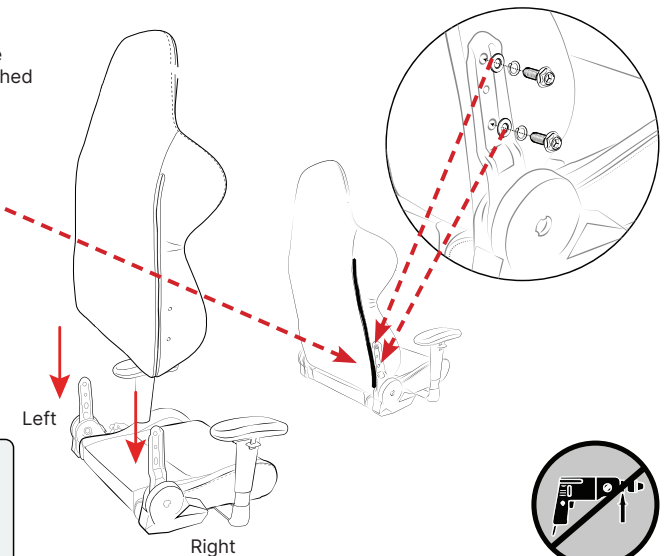
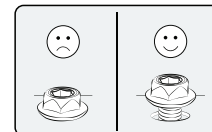

Xpression PRO Gaming Chair

Assembly Instructions // For any questions, please call us at 631.656.1066 or email Info@Zipchair.com



Step 3

Align tilt mechanism to underside of seat bottom.

Attach adjustment handles to each side of mechanism.

Note: Make sure tilt mechanism is facing the correct way, as shown in the diagram.

(Tilt adjustment resistance rotator should be towards the front of the chair).

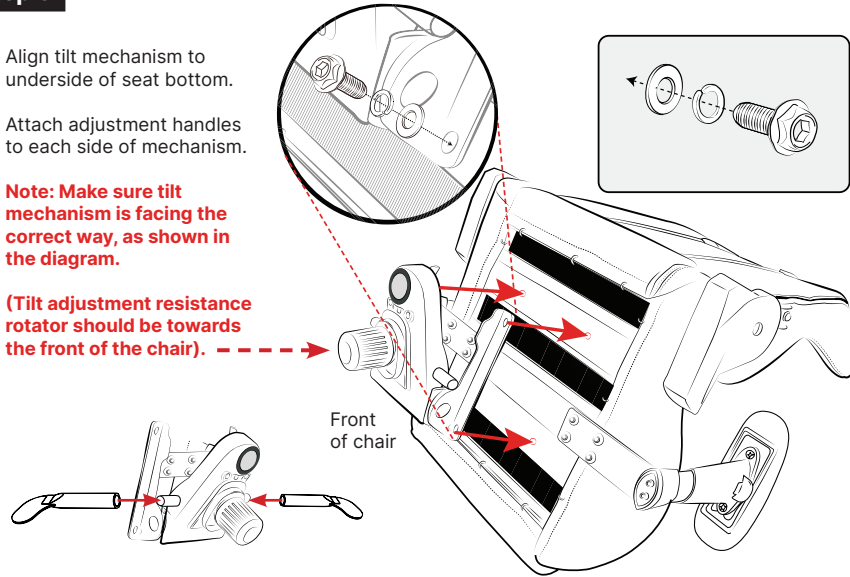

Step 4

Apply recliner mechanism covers to the side of the chair.

Apply cover caps to hide bolts once the covers are attached.

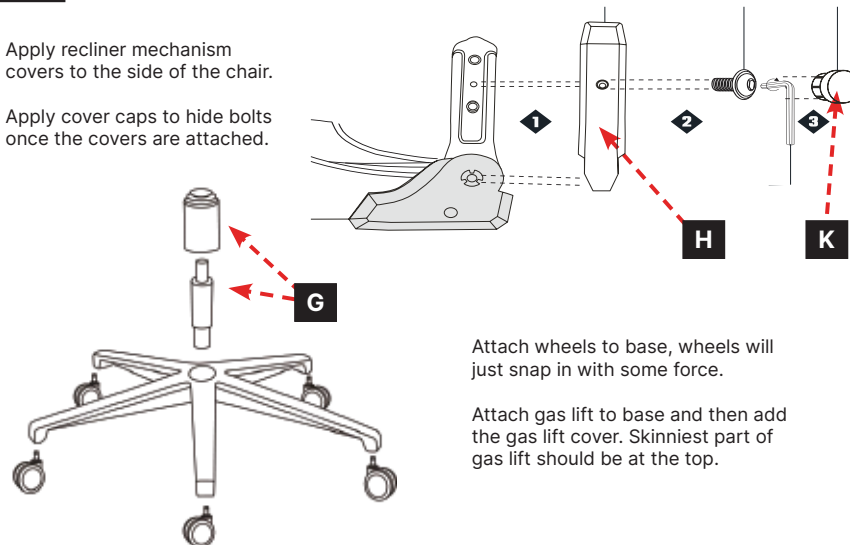

Attach wheels to base, wheels will just snap in with some force.

Attach gas lift to base and then add the gas lift cover. Skinniest part of gas lift should be at the top.

Step 5

Optional Step: Only if you purchased a logo panel.

Note: Connect both zippers before zipping them down the chair.

Attach your pillows to the headrest and lower back area.

Both pillows attach via magnets and can be adjusted up and down in those areas.

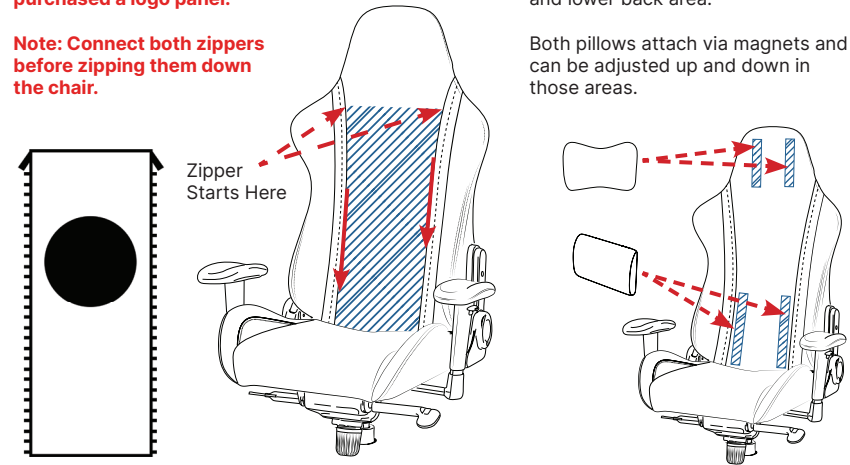

Additional Information

Assembly Instructions Video Guide:

Scan the QR code with your smart device to watch our Xpression PRO assembly instructions video.

Email us at Info@Zipchair.com for any assembly questions or replacement parts.



Scan with Phone to Watch Video

